

Trampoline Ladder

Assembly Instruction

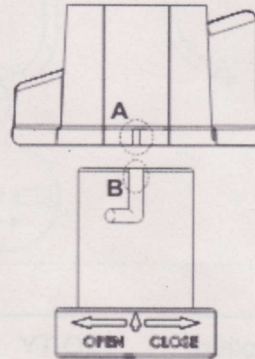

Align A to B.

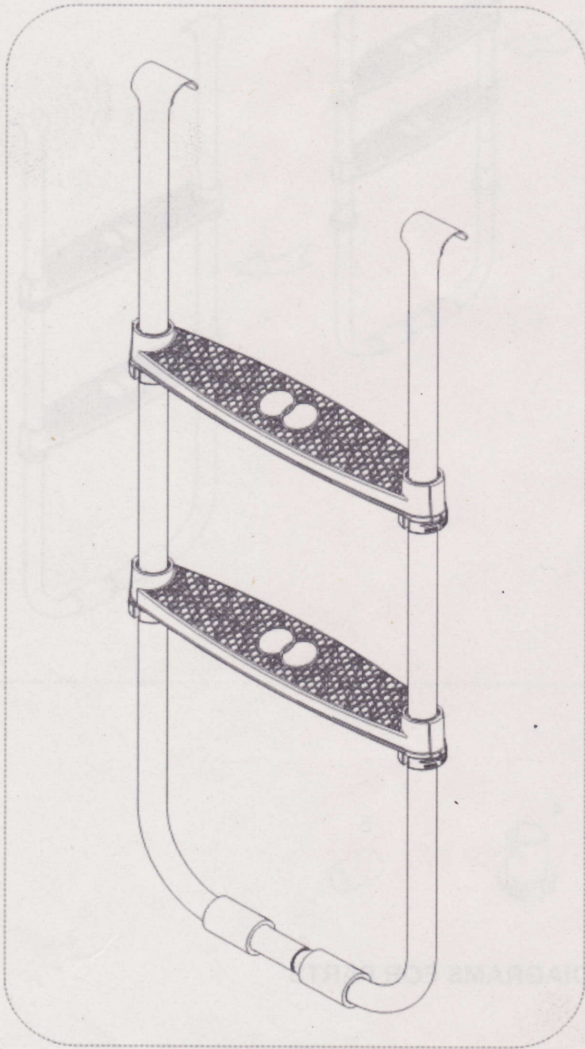
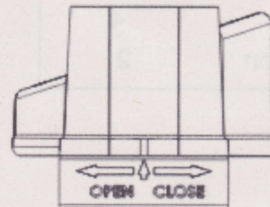

Slide step to socket.

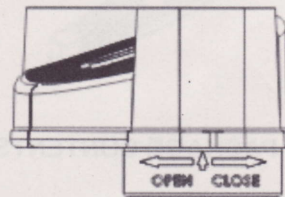

Rotate socket according to arrowhead Direction.

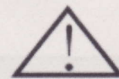

Warning: the bulge of lining must be block the tube's groove , when you setting the Ladder. Otherwise, the footplate can easy to be broken installation course.

While not using trampoline, please keep the ladder in place to avoid children under six years old using.

ASSEMBLY INSTRUCTION

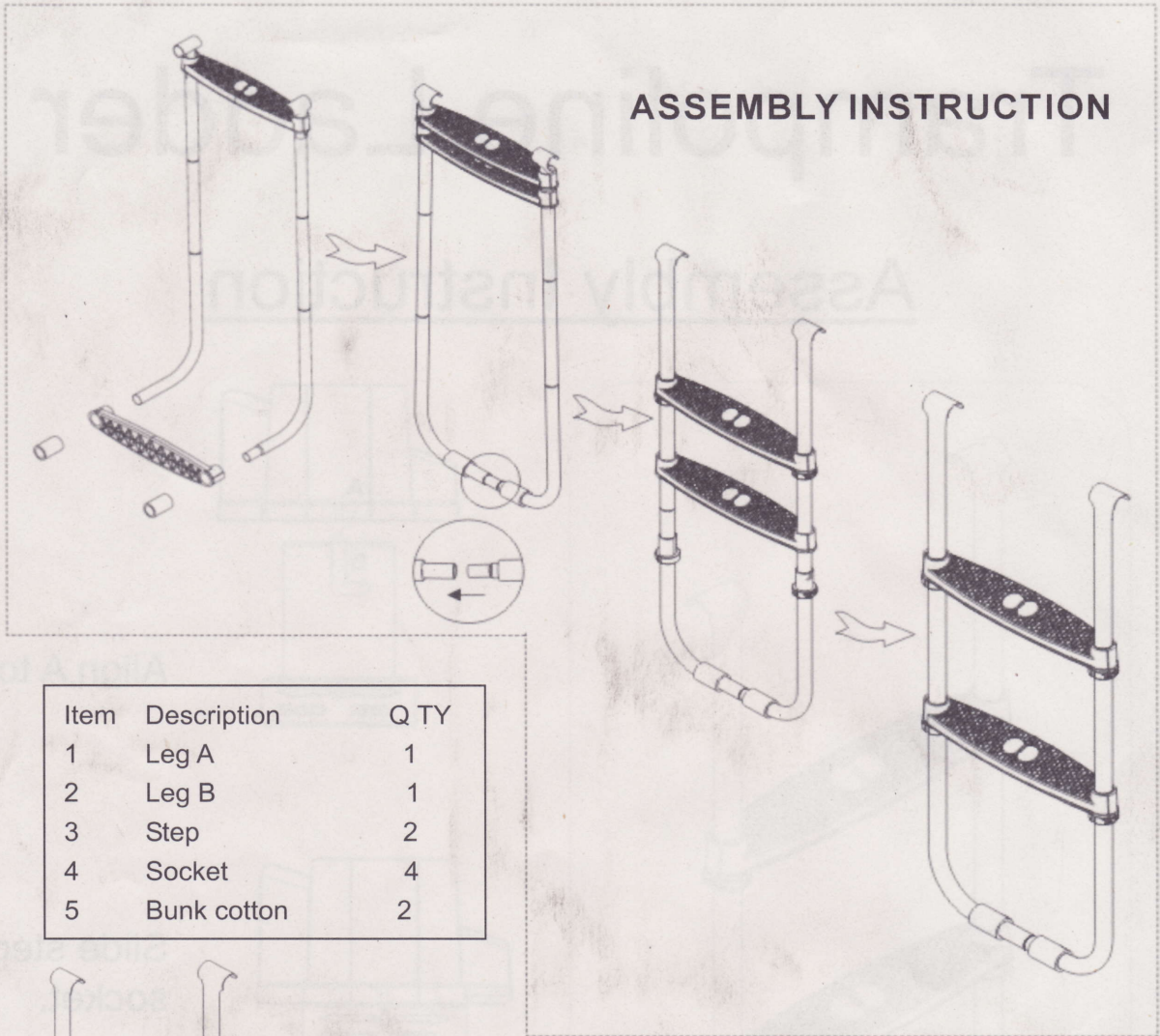

Item	Description	QTY
1	Leg A	1
2	Leg B	1
3	Step	2
4	Socket	4
5	Bunk cotton	2

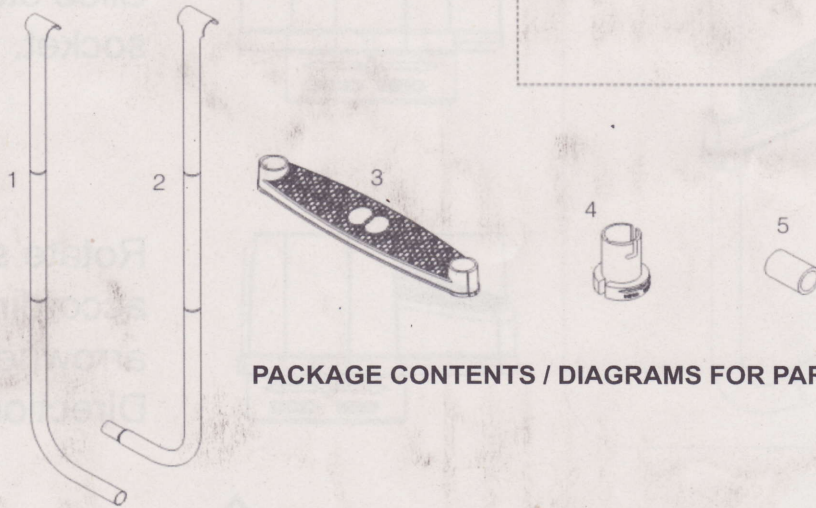

PACKAGE CONTENTS / DIAGRAMS FOR PARTS

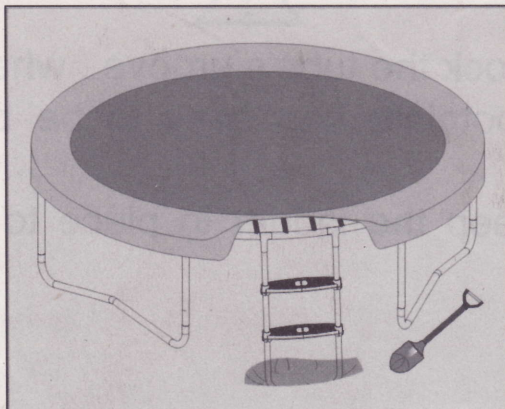

Note: The 8ft and 10ft trampoline's height a little low. When you use this ladder, it maybe The length of the ladder is too long. Making the steps point down when you climb up to the trampoline which is not that safe. Please Dig a hole, you can make the ladder treads completely flat.